

Contents

Before use		
Safety Precautions	3	
General features		
Power	5	
Switching Modes	5	
Sirius satellite radio tuner features		
Selecting Sirius Mode	6	
Switching Seek Mode	6	
Selecting the Preset Band	6	
Channel Preset Memory	7	
Preset Tuning	7	
Channel Scan	7	
Channel Search	7	
Direct Access Tuning	8	
Switching Display	8	
Disc control features		
Playing Disc	9	
Fast Forwarding and Reversing	9	
Track Search	9	
Disc Search	10	
Direct Track Search	10	
Direct Disc Search	10	
Track/Disc Repeat	10	
Track Scan	10	
Random Play	10	
Magazine Random Play	11	
Folder Search	11	
Text/Title Scroll	11	
Switching Display	11	
Menu system		
Menu system	12	
Changing the Transmission Frequency	13	
Modulation level	13	
Dynamic control	13	
Text Scroll	13	
Sirius ID (ESN)	14	
Basic Operations of remote		15
Installation		
Accessories	17	
Installation Procedure	17	
Connecting Wires to Terminals	18	
Installation	20	
Troubleshooting guide		21
Specifications		25

Safety Precautions

⚠WARNING

Take the following precautions to prevent fire and avoid personal injury:

- When extending the ignition wire, battery wire, or ground wire, use 0.75mm² (AWG18) or larger automotive grade wire to avoid wire deterioration or damage to the covering.
- Check that no metal objects (coins, tools, etc.) are left inside the unit to avoid short circuits.
- If you smell or see smoke, turn the power off immediately and consult your Kenwood dealer.
- Do not touch the liquid crystal fluid if the LCD is damaged or broken due to shock. The liquid crystal fluid may be dangerous to your health or even fatal.
If the liquid crystal fluid from the LCD contacts your body or clothing, wash it off with soap immediately.

⚠CAUTION

Take the following precautions to keep the unit in proper working order.

- Be sure the unit is connected to a 12V DC power supply with a negative ground connection.
- Do not open the top or bottom cover.
- Do not install the unit in places it is exposed to direct sunlight, high heat or humidity, water may splash over it, or dust exists.

- When replacing a fuse, only use a new one with the prescribed rating. Using a fuse with the wrong rating may cause your unit to malfunction.
- To prevent a short circuit when replacing a fuse, first disconnect the wiring harness.

NOTE

- If you have difficulty in installing this unit in your vehicle, contact your Kenwood dealer.
- If it doesn't seem to be working properly, first press the Reset button. If the malfunction persists, consult your Kenwood dealer.

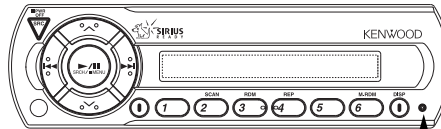

Reset button

- Some car stereos cause the sound of the tuner to make for a moment when an engine is activated.
- The reception of the tuner may be reduced a little if the KCA-R70FM is used.
- If the sound is lower than the tuner sound, raise up the volume level of the CD/MD with using the receiver.
- Do not use your own screws. Use only the screws provided. If you use the wrong screws, you could damage the unit.

IMPORTANT INFORMATION

About the disc changer to be connected:

To connect a disc changer having the "O-N" switch to this unit, set the "O-N" switch to "N". Note that none of the KDC-C100, KDC-C302, C205, C705, and non-Kenwood CD changers can be connected.

⚠ You can damage both your unit and the CD changer if you connect them incorrectly.

Precautions when connecting disc changers released in 1997 or earlier.

The optional switching adapter KCA-S210A is necessary to connect a disc changer that is not equipped with the "O-N" switch except KDC-C100, KDC-C302, C205 and C705.

Cleaning the Unit

If the front panel gets dirty, turn off the power and wipe the panel with a dry silicon cloth or soft cloth.

⚠CAUTION

Do not use hard cloths or paint thinner, alcohol, or other volatile solvents. These may damage external surfaces or remove indicator characters.

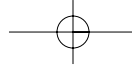

English

Safety Precautions

FCC WARNING

This equipment may generate or use radio frequency energy. Changes or modifications to this equipment may cause harmful interference unless the modifications are expressly approved in the instruction manual. The user could lose the authority to operate this equipment if an unauthorized change or modification is made.

NOTE

This Class B digital apparatus complies with Canadian ICES-003.

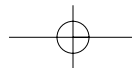

General features

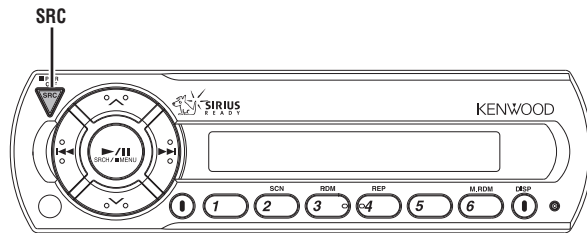

Set the car radio FM station to 88.3 MHz. See Page 13 for more information on changing the transmission frequency.

Power

Turning ON the Power

Press the [SRC] button.

Turning OFF the Power

Press the [SRC] button for at least 1 seconds.

The FM modulator is turned OFF and the radio can be heard.



- Be sure to turn down the volume whenever you listen to the radio or a cassette tape after stopping the disc play.
- During the disc play is being conducted, you are not able to receive ordinary Radio broadcasting because antenna output is switched into compact disc player's side.

Switching Modes

Press the [SRC] button.

Source required	Display
Sirius	"SIRIUS"
CD/MD auto-changer	"CHANGER"/"CHANGER-1"/ "CHANGER-2"
Auxiliary input	"AUX"
Off	



For Auxiliary input one of the below optional accessories is necessary.

- KCA-S210A
- CA-C1AX
- CD changer with an Auxiliary input function installed.

Sirius satellite radio tuner features

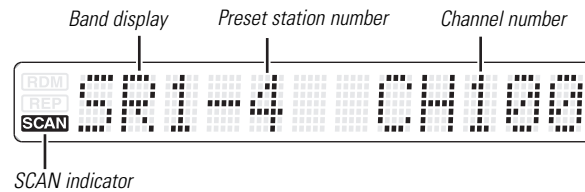
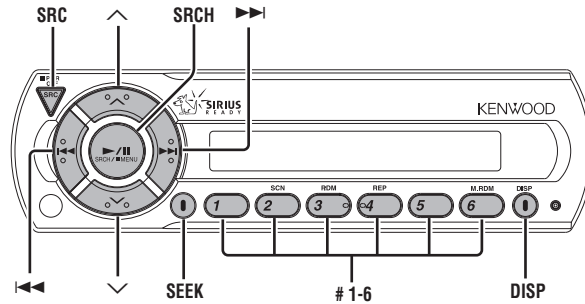

Selecting Sirius Mode

Press the [SRC] button.
Select the "SIRIUS" display.

- You need to subscribe to SIRIUS to receive the service by Sirius Satellite Radio. Consult SIRIUS if "CALL 888-539 SIRIUS TO SUBSCRIBE" appears.
- It may take a little time to start receiving after you selected the SIRIUS source.
- If the signal receiving fails, "ACQUIRING SIGNAL" appears.

Switching Seek Mode

Sets the seeking mode.

Press the [SEEK] button.

Each time the button is pressed the Seek mode switches as shown below.

Display	Operation
"SEEK 1"	Normal manual seeking control.
"SEEK 2"	Search in order of the channels in the Preset memory.

- You cannot operate this unit during switching Channel or Category.

Selecting the Preset Band

Press the [^] button.

Each time the button is pressed the preset band switches between the SR1,SR2,SR3, and SR4.

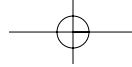

Channel Preset Memory

Putting the channel in the memory.

- 1 Select the preset band**
Press the [^] button.
- 2 Select the channel to put in the memory**
Press the [◀◀] or [▶▶] button.
- 3 Put the channel in the memory**
Press the [#1] — [#6] button for at least 2 seconds.
The preset number display blinks 1 time.
On each band, 1 channel can be put in the memory on each [#1] — [#6] button.

 Only the channel number is stored. Category information is not stored.

Preset Tuning

Calling up the channels in the memory.

- 1 Select the preset band**
Press the [^] button.
- 2 Call up the channel**
Press the [#1] — [#6] button.

Channel Scan

Scanning for the channel you want to listen to.

- 1 Start Channel Scan**
Press the [SEEK] button for at least 1 second.
"SCAN" indicator is ON.

2 Release it when the channel you want to listen to is received

Press the [SEEK] button for at least 1 second.

Channel Search

You can switch from Up/Down of Channel in a category being selected to Previous/Next of Category that includes Channel being received and vice versa.

- 1 Enter Channel Search mode**
Press the [SRCH] button.
- 2 Select the Category**
Press the [^] or [v] button.
- 3 Select the Channel**
Press the [◀◀] or [▶▶] button.

Canceling Channel Search

Press the [SRCH] button.

 You cannot operate this unit until all the Category information is acquired.

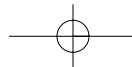

Sirius satellite radio tuner features

Direct Access Tuning (Function of remote)

Entering the channel and tuning.

1 Enter Direct Access Tuning mode

Press the [DIRECT] button on the remote.

2 Enter the channel number

Press the number buttons.

3 Do Channel Search

Press the [◀◀] or [▶▶] button.

Canceling Direct Access Tuning

Press the [DIRECT] button on the remote.



- If you make no button operation for 10 seconds, the Direct Access Tuning mode is automatically canceled.
- You can set up to Channel number 223.
- If there is no signal in the input Channel, "NO CHANNEL" appears.
- If you cannot receive any signal in the input Channel due to a bad condition on radio wave or another problem, "ACQUIRING SIGNAL" appears.

Switching Display

You can display various kinds of text data transmitted from broadcasting stations by switching as follows.

Press the [DISP] button.

Each time the button is pressed the display switches as shown below.

Information	Display
Channel Number	
Channel Name	"CHANNEL"
Song Title	"SONG"
Artist Name	"ARTIST"
Category Name	"CATEGORY"
Album Title	"ALBUM"

Disc control features

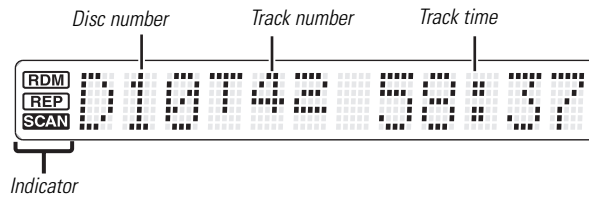
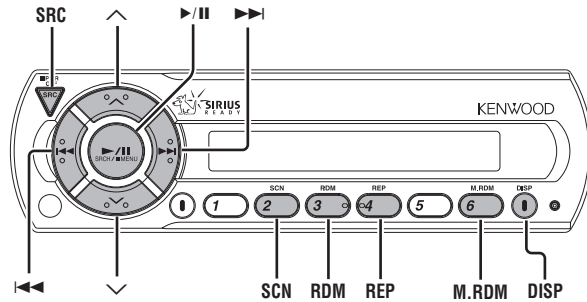

Playing Disc

Play:

Press the [SRC] button.
Select the "CHANGER"/"CHANGER-1"/ "CHANGER-2" display.

Stop the play:

Press the [SRC] button for at least 1 second.
The FM modulator is turned OFF and the radio can be heard.

Pause and play:

Press the [▶/⏸] (▶⏸...Remote) button.
Each time the button is pressed it pauses and plays.
If you press the switch once more, the disc is replayed from the paused part.

 This unit enables control of an MP3-compatible disc auto-changer. MP3 media formats, refer to the instruction manual of the MP3-compatible disc auto-changer to be connected.

Fast Forwarding and Reversing

Fast Forwarding

Hold down on the [▶▶] button.
Release your finger to play the disc at that point.

Reversing

Hold down on the [◀◀] button.
Release your finger to play the disc at that point.

Track Search

Searching for a song on the disc or in the MP3 folder.

Press the [◀◀] or [▶▶] button.

Disc control features

Disc Search

Selecting the disc set in the Disc changer.

Press the [^] or [v] button.

Direct Track Search (Function of remote)

Doing Track Search by entering the track number.

1 Enter the track number

Press the number buttons on the remote.

2 Do Track Search

Press the [T.UP] or [T.DOWN] button.

Canceling Direct Track Search

Press the [▶||] button.

Direct Disc Search (Function of disc changers with remote)

Doing Disc Search by entering the disc number.

1 Enter the disc number

Press the number buttons on the remote.

2 Do Disc Search

Press the [+] or [-] button.

Canceling Direct Disc Search

Press the [▶||] button.

 Input "0" to select disc 10.

Track/Disc Repeat

Replaying the song, disc in the Disc changer or MP3 folder you're listening to.

Press the [REP] button.

When it's ON, the "REP" indicator is ON.

Each time the button is pressed the Repeat Play switches as shown below.

Repeat play	Display
Track Repeat	Track No. blinks.
Disc Repeat	Disc No. blinks.
OFF	—

Track Scan

Playing the first part of each song on the disc or MP3 folder you are listening to and searching for the song you want to listen to.

1 Start Track Scan

Press the [SCN] button.

"SCAN" indicator is ON.

2 Release it when the song you want to listen to is played

Press the [SCN] button.

Random Play

Play all the songs on the disc or MP3 folder in random order.

Press the [RDM] button.

Each time the button is pressed Random Play turns ON or OFF. When it's ON, the "RDM" indicator is ON and the track number blinks.

 When the [▶||] button is pressed, the next song select starts.

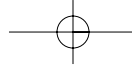

**Magazine Random Play
(Function of disc changer)**

Play the songs on all the discs in the disc changer in random order.

Press the [M.RDM] button.

Each time the button is pressed the Magazine Random Play turns ON or OFF.

When it's ON, the "RDM" indicator is ON and the track and disc number blink.

 When the [▶▶] button is pressed, the next song select starts.

Text/Title Scroll

Scrolling the displayed CD text, or MD title.

Press the [DISP] button for at least 1 second.

Switching Display

Switching the information displayed.

Press the [DISP] button.

Each time the button is pressed the display switches as shown below.

Information	Display
P-Time	
A-Time	
Disc title	"DISC TITLE"
Track title	"TRACK TITLE"

Folder Search (Function of MP3)

Selecting the folder you want to listen to.

1 Enter Folder Search mode

Press the [▶/||] (▶||...Remote) button.

 File No. display changes to Folder No. display during the Folder Search mode.

2 Select the folder

Press the [^] or [v] button.

With the [v] button you move to the previous folder, and with the [^] button to the next folder.

3 Decide the folder to play

Press the [▶/||] (▶||...Remote) button.

The Folder Search mode releases, and the MP3 in the folder being displayed is played.

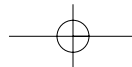

Menu system

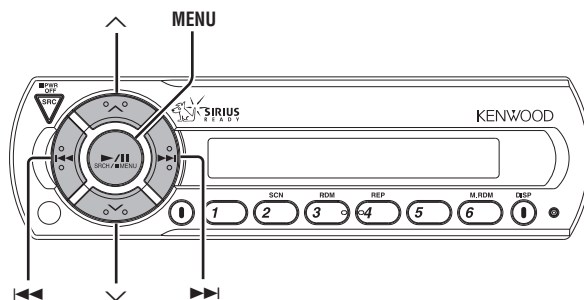

Menu System

The Menu system basic operation method is explained here. The reference for the Menu items and their setting content is after this operation explanation.

1 Enter Menu mode

Press the [MENU] button for at least 1 second.
"MENU" is displayed.

2 Select the menu item

Press the [^] or [v] button.

3 Set the menu item

Press the [◀◀] or [▶▶] button.
You can continue by returning to step 2 and setting other items.

4 Exit Menu mode

Press the [MENU] button.

 When other items that are applicable to the basic operation method above are displayed afterwards their setting content chart is entered.

Changing the Transmission Frequency

Select the frequency.

Display	Value
"T-FREQ 87.7"	87.7 MHz
"T-FREQ 87.9"	87.9 MHz
"T-FREQ 88.1"	88.1 MHz
"T-FREQ 88.3"	88.3 MHz (Initial setting)
"T-FREQ 88.5"	88.5 MHz
"T-FREQ 88.7"	88.7 MHz
"T-FREQ 88.9"	88.9 MHz
"T-FREQ 89.1"	89.1 MHz
"T-FREQ 89.3"	89.3 MHz
"T-FREQ 89.5"	89.5 MHz
"T-FREQ 89.7"	89.7 MHz
"T-FREQ 89.9"	89.9 MHz

 Some car radios cannot receive a 87.7 MHz frequency.

Modulation level

Select the modulation level.

Display	Value
"MOD LEVEL 1"	1
"MOD LEVEL 2"	2 (Initial setting)
"MOD LEVEL 3"	3
"MOD LEVEL 4"	4

Dynamic control

Setting the Dynamic control.

Display	Setting
"D-CONT ON"	The dynamic control is ON.
"D-CONT OFF"	The dynamic control is OFF. (Initial setting)

 The unit comes with the prevention of distortion function to reduce sound distortion.

If the sound is distorted severely, press the [◀◀] or [▶▶] button on the display unit and then set the function to "ON". If the prevention of distortion function is set to "ON", the sound extension is reduced.

 If a disc with a high recording level is used, the sound may distort even if the prevention of distortion function is set to "ON". In this case, reduce the modulation level.

Text Scroll

Setting the displayed text scroll.

Display	Setting
"SCROLL MANU"	Doesn't scroll.
"SCROLL AUTO"	Scrolls when the display changes.

 The texts scrolled are shown below.

- CD text
- Song title/ Artist name/ Album title/ Category name
- MD title

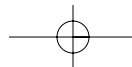

English

Menu system

**Sirius ID (ESN)
<When the KTC-SR901 is connected>**

Sirius ID (Electronic Serial Number) is displayed.

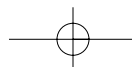
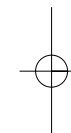
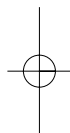

Basic Operations of remote

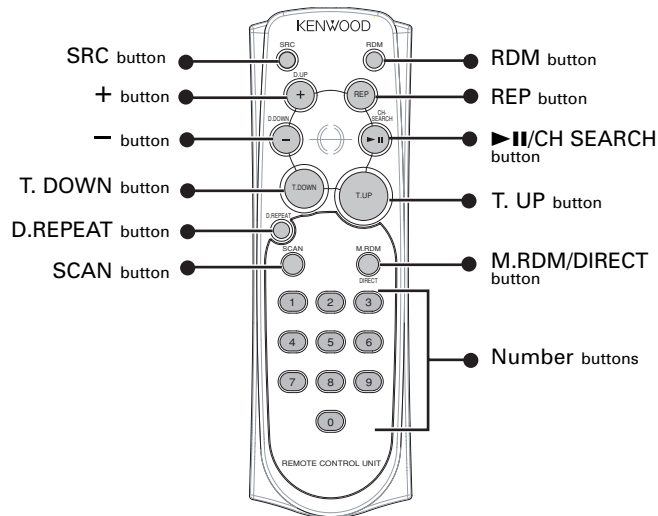

Loading and Replacing the battery

Use two "AAA" batteries.
Slide the cover while pressing downwards to remove it as illustrated.
Insert the batteries with the + and - poles aligned properly, following the illustration inside the case.

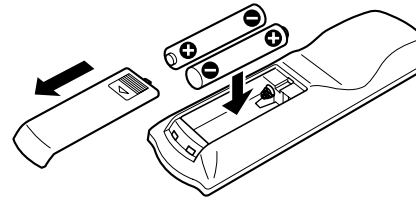

⚠ WARNING

Store unused batteries out of the reach of children. Contact a doctor immediately if the battery is accidentally swallowed.

- The provided batteries are intended for use in operation checking, and their service life may be short.
- When the remote controllable distance becomes short, replace both of the batteries with new ones.
- A portion of the operations may not be possible, depending on the unit that is connected.

⚠ Do not set the remote on hot places such as above the dashboard.

Basic operations

[SRC] button

Each time the button is pressed the source switches.

Basic Operations of remote

In Sirius source

[+] buttons

Select the band.

Each time the [+] button is pressed it switches between the SR1, SR2, SR3, and SR4 bands.

[T.UP]/ [T.DOWN] buttons

Tune up or down the channels.

Number buttons

Press buttons [#1] — [#6] to recall preset channels.

[DIRECT] button

Enters and cancels the <Direct Access Tuning> (page 8) mode.

[CH SEARCH] button

Enters and cancels the <Channel Search> (page 7) mode.

[SCAN] button

Each time the button is pressed Channel Scan turns ON or OFF.

In Disc source

[T.UP]/ [T.DOWN] buttons

Doing track forward and backward.

[+]/ [-] buttons

Doing disc forward and backward.

[▶||] button

Each time the button is pressed the song pauses and plays.

[REP] button

Each time the button is pressed Track Repeat function turns ON or OFF.

[D.REPEAT] button

Each time the button is pressed Disc Repeat function turns ON or OFF.

[RDM] button

Each time the button is pressed Random Play turns ON or OFF.

[M.RDM] button

Each time the button is pressed Magazine Random function turns ON or OFF.

[SCAN] button

Each time the button is pressed Trak Scan function turns ON or OFF.

Number buttons

When in <Direct Track Search> (page 10) and <Direct Disc Search> (page 10), enter the track/disc number.

Accessories

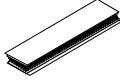
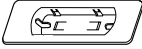
External view	Number of items
① 2
② 1
③ 1

 The use of any accessories except for those provided might result in damage to the unit. Make sure only to use the accessories shipped with the unit, as shown above.

Installation Procedure

1. To prevent a short circuit, remove the key from the ignition and disconnect the ⊖ battery.
2. Make the proper input and output wire connections for each unit.
3. Connect the wiring harness wires in the following order: ground, battery, ignition.
4. Install the unit in your car.
5. Reconnect the ⊖ battery.
6. Press the reset button.

▲WARNING

When drilling a hole in the car chassis to install the unit, check first that nothing is on the other side.

▲CAUTION

- If the fuse blows, first make sure the wires aren't touching to cause a short circuit, then replace the old fuse with one with the same rating.
- Do not let unconnected wires or terminals touch metal on the car or anything else conducting electricity. To prevent a short circuit, do not remove the caps on the ends of the unconnected wires or the terminals.
- After the unit is installed, check whether the brake lamps, blinkers, wipers, etc. on the car are working properly.
- Insulate unconnected wires with vinyl tape or other similar material.
- Some disc changers require optional equipment for connection. See the section on "Safety Precautions" for details.

Connecting Wires to Terminals

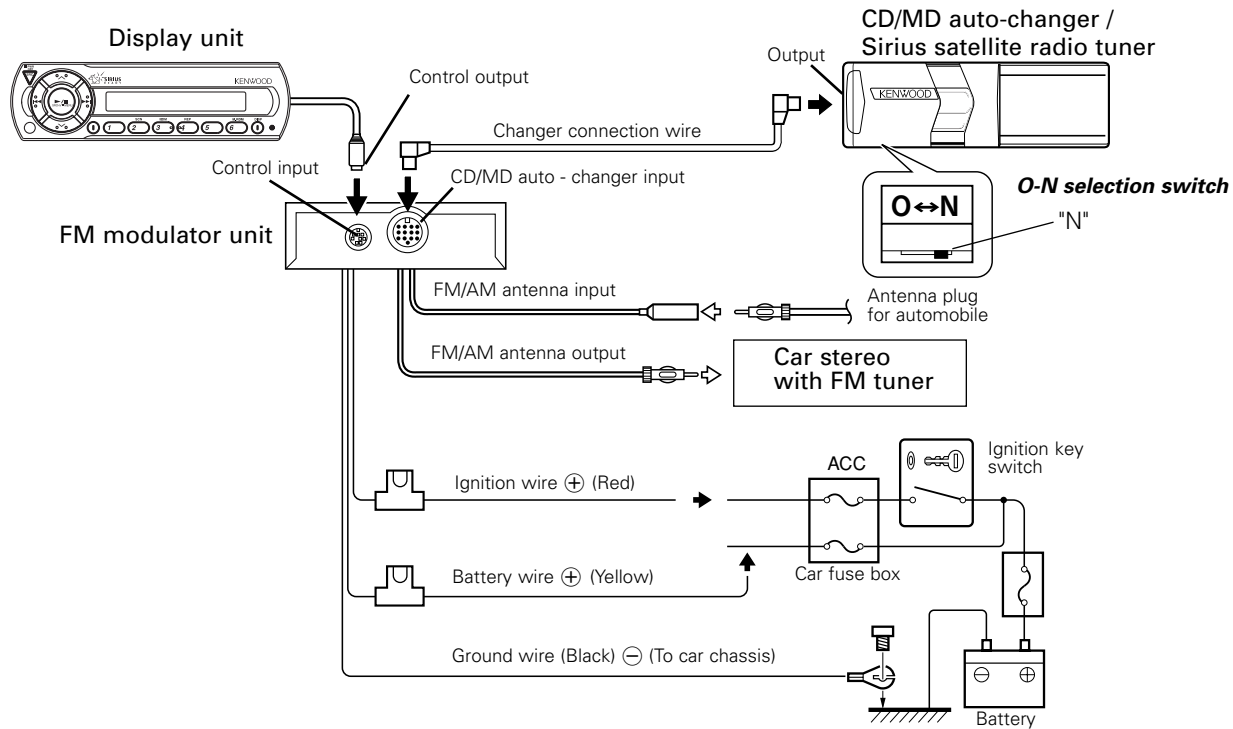

▲WARNING

To prevent fire when the ignition wire (Red) or battery wire (Yellow) is short-circuited by coming into contact with the vehicle chassis (ground), only connect the power supply after making the fuse box connections.

▲CAUTION

Be sure to press the reset button after installation.

Do not install an antenna of radio equipment or distribute the antenna wire near the changer output wire, for this could cause malfunction with this unit.

■ **If you want to connect disc changers released in 1997 or earlier**

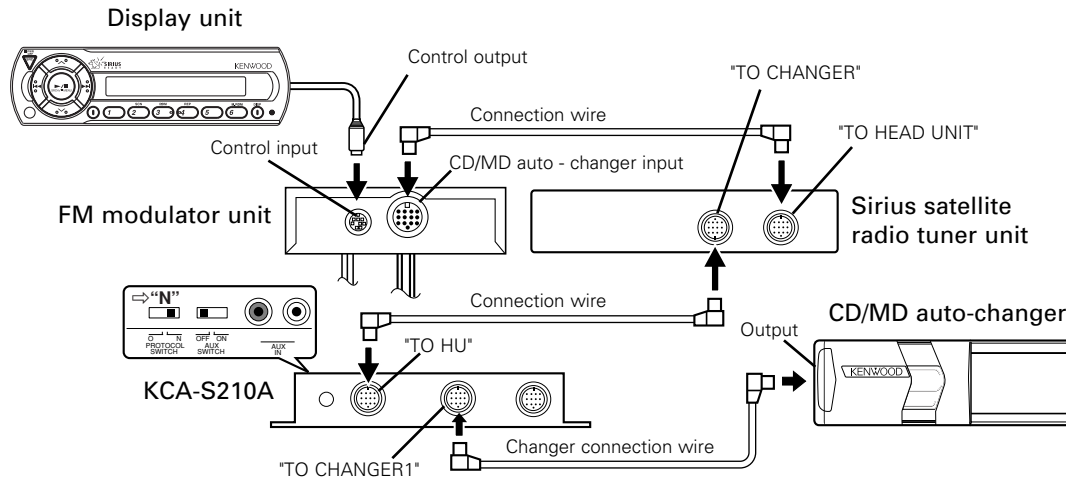

- Set the PROTOCOL selection switch to the "N" position.
- The KCA-S210A must be connected to the Sirius satellite radio tuner unit if they are connected at the same time.
- Up to two units of the Sirius satellite radio tuner unit or disc autochanger can be connected at the same time.

Installation

■ Installation of Display unit

- Installation without using the trim mount plate ③

Display unit

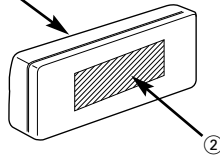

Attach one strip of Velcro to the slanted-line of the the display units as shown to the left, and attach the other strip of Velcro to the parts where you wish to attach the display units. Then, put velcros together and install the display units.

- Installation using the trim mount plate ③

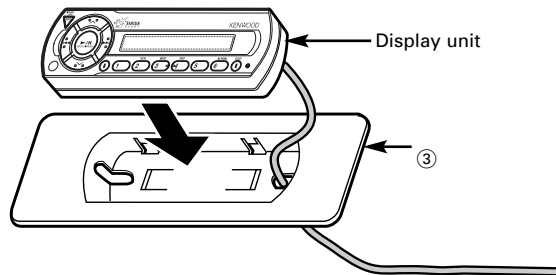

Pass the wire from the display unit through the hole on the trim mount plate and push fit the display unit into the trim mount plate until it locks.

▲CAUTION

- Be sure not to place the unit on such place as where it is exposed to direct sunlight and temperature eventually rises. It results in the deformation of the case.
- Depending on the installing location, the display unit may not be able to receive the signals from the controller unit. Install them after confirming that the signals can be received.
- Install the unit in such a way that it does not disturb driving.

■ Installation of FM modulator unit

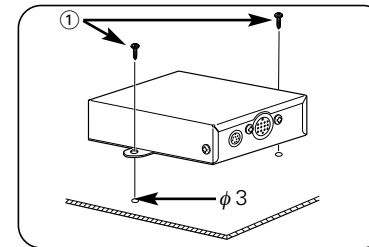

▲CAUTION

Take sufficient care so that the wires are not caught under the seat. If they are caught, they may break.

Install the FM modulator unit beneath the front seat using Metal fixture and Bind head screw as shown in the above figure.

Troubleshooting Guide

What might seem to be a malfunction in your unit may just be the result of slight misoperation or miswiring. Before calling service, first check the following table for possible problems.

General

? The power does not turn ON.

- ✓ The fuse has blown.
 - ✎ After checking for short circuits in the wires, replace the fuse with one with the same rating.
- ✓ No ACC position on vehicle ignition.
 - ✎ Connect the same wire to the ignition as the battery wire.

? Nothing happens when the buttons are pressed.

- ✓ The computer chip in the unit is not functioning normally.
 - ✎ Press the Reset button on the display unit (page 3).

? No sound or sound is low.

- ✓ The O-N selection switch of the disc changer is not set properly.
 - ✎ Set the O-N selection switch to "N" position.
- ✓ The radio volume is sets to the minimum level.
 - ✎ Turn the radio volume up.
- ✓ The input/output wire or wiring harness is connected incorrectly.
 - ✎ Connect the input/output wire or wiring harness correctly. See "Connecting Wires to Terminals" (Page 18,19).

? Sound distortion.

- ✓ The signal levels differ depending on sources.
 - ✎ Change the Modulation level / Dynamic control setting. (Page 13)

? Nothing appears on the display.

- ✓ The control output of the display unit is not connected properly.
 - ✎ Connect the control output properly.

Sirius source

? The Sirius mode cannot be selected.

- ✓ The Sirius connection wire is not connected.
 - ✎ Use the Sirius connection wire to connect the control unit and the Sirius satellite radio tuner.
- ✓ Connect the power supply of the Sirius satellite radio tuner.
 - ✎ Connect the battery wire and ground wire to the Sirius satellite radio tuner.
- ✓ The Sirius satellite radio tuner is not connected properly.
 - ✎ Connect the Sirius satellite radio tuner directly to this unit.

? No sound can be heard, or the volume is low.

- ✓ The input/output wires or wiring harness are connected incorrectly.
 - ✎ Reconnect the input/output wires and/or the wiring harness correctly.

? No broadcast can be received

- ✓ The Sirius antenna is not connected.
 - ✎ Connect it properly.
- ✓ No subscription is established.
 - ✎ Subscribe to SIRIUS.

? No sound is heard even though the information concerning the Sirius satellite radio tuner is displayed.

- ✓ The radio volume is sets to the minimum level.
 - ✎ Turn the radio volume up.
- ✓ The microcomputer does not function correctly.
 - ✎ Press the Reset button of the display unit.(Page 3)
- ✓ The system is not connected properly.
 - ✎ Connect the system properly. See <Connecting Wires to Terminals>. (Page 18,19)

Troubleshooting Guide

Disc source

? CD/MD play does not start.

- ✓ CD/MD auto-changer input is not connected to the unit.
 - ☞ Connect the CD/MD auto-changer input to the unit.
- ✓ Power button is not turned ON.
 - ☞ Turn the power button ON.
- ✓ The PROTOCOL selection switch of the changer switching unit "KCA-S210A" is not set properly.
 - ☞ Set the PROTOCOL selection switch to "N" position.

? The specified disc does not play, but another one plays instead.

- ✓ The specified CD is quite dirty.
 - ☞ Clean the CD.
- ✓ The CD is upside-down.
 - ☞ Load the CD with the labeled side up.
- ✓ The disc is loaded in a different slot from that specified.
 - ☞ Eject the disc magazine and check the number for the specified disc.
- ✓ The disc is severely scratched.
 - ☞ Try another disc instead.

? The specified track will not play.

- ✓ Random play or magazine random play has been selected.
 - ☞ Turn off random play or magazine random play.

? Cannot play CD-R or CD-RW.

- ✓ Finalization processing is not being conducted for CD-R/CD-RW.
 - ☞ Conduct finalization processing with CD recorder.

? Direct Track Search and Direct Disc Search can't be done.

- ✓ Another function is ON.
 - ☞ Turn Random Play or other functions OFF.

? Track Search can't be done.

- ✓ For the discs first or last song.
 - ☞ For each disc, Track Search can't be done in the backward direction for the first song or in the forward direction for the last song.

? Sound skips due to vibration.

- ✓ Something is touching the CD/MD auto-changer.
 - ☞ Keep it away from the CD/MD auto-changer.
- ✓ The disc is dirty or damaged.
 - ☞ If sound skips at the same part, the disc is faulty. Check and, if possible, clean the disc.
- ✓ Changer unit is mounted on the a slant.
 - ☞ Mount the unit so that is level.
- ✓ Changer unit is mounted in an unstable place.
 - ☞ Mount the unit in a stable place.
- ✓ The angle adjustment switches are set improperly.
 - ☞ Set the angle adjustment switches to the correct positions.

? Sound quality is poor.

- ✓ The recording of the disc is poor.
 - ☞ Try playing another disc. If the sound is good, the fault was with the original disc.
- ✓ The disc is dirty or damaged.
 - ☞ Check and, if possible, clean the disc.

? No sound is heard even though the information concerning the CD/MD auto-changer is displayed.

- ✓ The radio volume is sets to the minimum level.
 - ☞ Turn the radio volume up.
- ✓ The microcomputer does not function correctly.
 - ☞ Press the Reset button of the display unit. (Page 3)
- ✓ The system is not connected properly.
 - ☞ Connect the system properly. See <Connecting Wires to Terminals>. (Page 18,19)

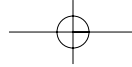

MP3 source

? Cannot play an MP3.

- ✓ The disc format is not accepted in the unit connected.
 - ☞ Refer to the instruction manual of the disc changer (slave unit) for creation of compatible formats.
- ✓ The MP3 has no or invalid track name extension.
 - ☞ Add the ".MP3" extension to the MP3 track name.
- ✓ The media is scratched or dirty.
 - ☞ Clean the media.

? Noise or no sound generated when an MP3 is played.

- ✓ The track has the MP3 track name extension while it is not an MP3.
 - ☞ Do not use the ".MP3" extension in non-MP3.

? Takes time before the unit starts playing MP3.

- ✓ The medium contains many discs, tracks, and hierarchical levels.
 - ☞ The unit checks all tracks on the loaded medium first. If the medium has many tracks recorded, it may take a long time for the unit before it starts playing MP3.

? Fails to play MP3 in the intended order.

- ✓ The MP3 tracks were not written by the CD writer in the order in which you wanted them to be played.
 - ☞ Depending on the CD writer, you may be able to set the order in which MP3 tracks are to be played by writing them onto a medium with their track names beginning with play sequence numbers such as "01" to "99".

? The sound skips when an MP3 is being played.

- ✓ The media is scratched or dirty.
 - ☞ Clean the media.
- ✓ The recording condition is bad.
 - ☞ Record the media again or use another media.

? The songs in the selected folder aren't played in Folder Search mode.

- ✓ There are no MP3 in the selected folder.
 - ☞ Make sure there's recorded content in the MP3 media.

? The MP3 track search takes time.

- ✓ Many tracks are recorded on the media.
 - ☞ When the media directory is complex, the track search can take time.

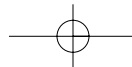

Troubleshooting Guide

The messages shown below display your systems condition.

- EJECT:** No disc magazine has been loaded in the changer. The disc magazine is not completely loaded.
 ⇨ Load the disc magazine properly.
- NO DISC:** No disc has been loaded in the disc magazine.
 ⇨ Load a disc into the disc magazine.
- TOC Error:** No disc has been loaded in the disc magazine.
 ⇨ Load a disc into the disc magazine.
 The CD/MD is quite dirty. The CD is upside-down. The CD is scratched a lot.
 ⇨ Clean the CD/MD and load it correctly.
- BLANK DISC:** Nothing has been recorded on the MD.
 ⇨ The next MD will automatically be played.
- No Track:** No tracks are recorded on the MD, although it has a title.
 ⇨ The next MD will automatically be played.
- E-12:** Now reading the data in the disc.
 ⇨ Normal playback is resumed upon completing the reading of the disc data.
- E-77:** The unit is malfunctioning for some reason.
 ⇨ Press the reset button on the display unit. If the "E-77" code does not disappear, consult your nearest service center.
- Mecha Error:** Something is wrong with the disc magazine. Or the unit is malfunctioning for some reason.
 ⇨ Check the disc magazine, and then press the reset button on the display unit. If the "Mecha Error" code does not disappear, consult your nearest service center.
- Hold Error:** The protective circuit in the unit activates when the temperature inside the automatic disc changer exceeds 60°C (140°F), stopping all operation.
 ⇨ Cool down the unit by opening the windows or turning on the air conditioner. As the temperature falls below 60°C (140°F), the disc will start playing again.
- ANTENNA ERR:** The antenna is not connected correctly.
 ⇨ Make sure the antenna is connected correctly and then turn OFF/ON the SIRIUS source or Display unit.
- TUNER ERROR:** Broadcast cannot be received due to an error in this unit.
 ⇨ Turn OFF/ON the SIRIUS source or Control unit, or press the reset button on the Display unit.
- ESN ERROR:** The ESN (Electronic Serial Number) is not registered in Sirius satellite radio tuner unit.
 ⇨ Consult your nearest service center.
- LINE ERROR:** Neither a disc changer nor the Sirius satellite radio tuner is connected.
 ⇨ Connect a disc changer or the Sirius satellite radio tuner.
 The number of disc changers and Sirius satellite radio tuners exceeds the limit of connection to this system.
 ⇨ Up to two units can be connected. Rearrange your connection not to exceed the limit of the connection.

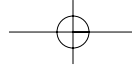

Specifications

Specifications subject to change without notice.

Modulating Frequency (200KHz STEP)87.7, 87.9, 88.1, 88.3,
88.5, 88.7, 88.9, 89.1,
89.3, 89.5, 89.7, 89.9
MHz

General

Operating Voltage.....14.4 V (11 ~ 16 V)
Current consumption1.4 A
Operating Temperature-10 ~ 50 °C

Size (W x H x D)

Remote Controller43 x 135 x 22 mm
(1-11/16 x 5-5/16 x 7/8 in.)
Display unit.....154 x 43 x 17 mm
(6-1/16 x 1-11/16 x 11/16 in.)
FM modulator unit150 x 30 x 80 mm
(5-7/8 x 1-3/16 x 3-1/8 in.)
Trim mount plate188 x 58 x 18 mm
(7-3/8 x 2-5/16 x 11/16 in.)

Weight

Remote Controller.....50 g (0.11 lbs)
Display unit145 g (0.32 lbs)
FM modulator unit460 g (1.01 lbs)

